

























N16

Datenblatt



Abbildung: N16 | Naturstein: Crema Marfil

Standard	Gesamtgewicht	Optional	Zubehör	Naturstein	Kamineinsatz	
 Front Kristall	 ca. 500 kg	 Front Kristall + (außer Lina W)	 Heizwasser-Aufsatzregister R	 Kesselgerät Lina W	 Lina 7363 h NW-Leistung: 9 kW Abgasstutzen: Ø 200 mm  Energieeffizienzklasse nach (EU) 2015/1186 für Kamineinsatz Mehr Infos unter www.camina-schmid.de	
 Tür hochschiebbar		 Doppelverglasung	 Aufsatzspeicher	 Warmluft-Aufsatzregister		
		 Tunnelversion	 Elektronischer Türantrieb	 Außenbefuerung		
			 SMR	 Vorlegeplatte		
				 Blanco Carrara		 Blanco Macael
				 Blanco Nacarado		 Caliza Moka
				 Crema Marfil		 Marron Emperador
				 Travertino Romano		 Negro Abanilla
				 Rojo Alicante		 Rosa Claro
				 Rosa Crema		
				Weitere Natursteinausführungen auf Anfrage erhältlich.		

N16

Maßzeichnung

Frontansicht M 1:25

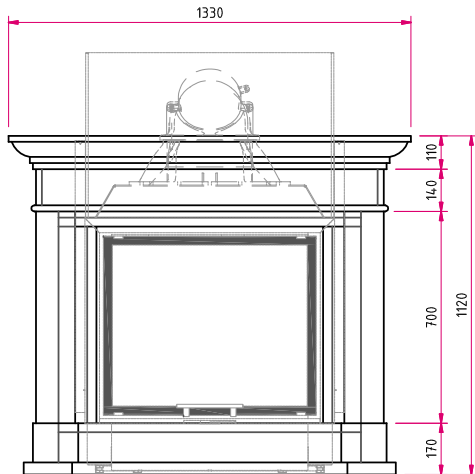

Seitenansicht M 1:25

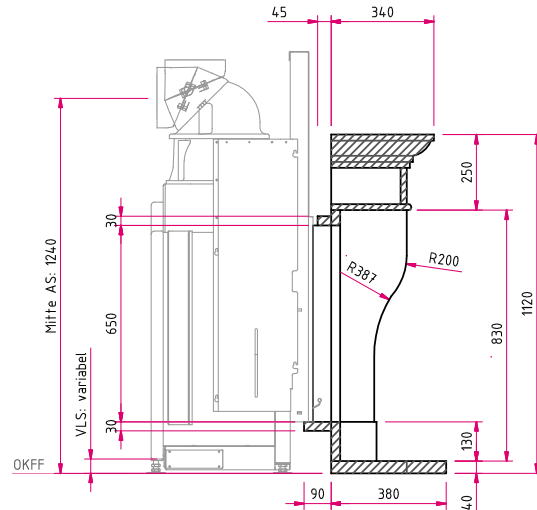

Draufsicht M 1:25

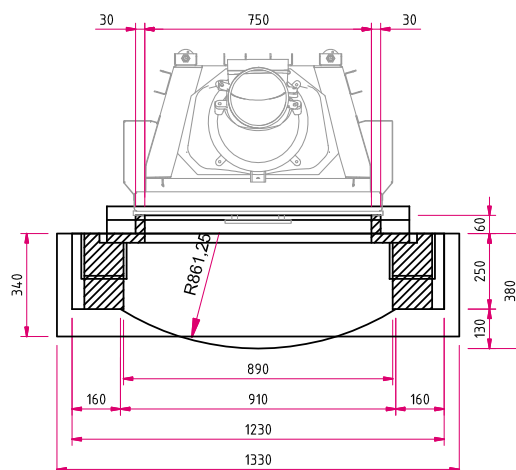

Hinweis Seitenansicht M 1:25: AS: Abgasstutzen, VLS: Verbrennungsluftstutzen, OKFF: Oberkante Fertigfußboden

Bitte beachten Sie die Angaben für **optionales Zubehör** in unserer Preisliste.

Abbildungen ähnlich. Alle Abbildungen und Zeichnungen sind urheberrechtlich geschützt. Verwertung oder Veröffentlichung, auch einzelner Details, nur mit unserer Genehmigung. Farbliche und technische Änderungen durch Weiterentwicklungen sowie Irrtümer vorbehalten. Stand: 07/2018