

























N28 Celine

Datenblatt



Abbildung: N28 (Celine) | Naturstein: Caliza Moka

Standard	Gesamtgewicht	Optional	Zubehör	Naturstein	Kamineinsatz
 Front Kristall	 ca. 365 kg	 Front Kristall + (außer Lina W)	 Heizwasser-Aufsatzregister R	 Kesselgerät Lina W	 Lina 7363 h NW-Leistung: 9 kW Abgasstutzen: Ø 200 mm  Energieeffizienzklasse nach (EU) 2015/1186 für Kamineinsatz Mehr Infos unter www.camina-schmid.de
 Tür hochschiebbar		 Doppelverglasung	 Aufsatzspeicher	 Warmluft-Aufsatzregister	
		 Tunnelversion	 Elektronischer Türantrieb	 Außenbefuerung	
			 SMR	 Vorlegeplatte	
				 <i>Blanco Carrara</i>	
				 <i>Blanco Macael</i>	
				 <i>Blanco Nacarado</i>	
				 <i>Caliza Moka</i>	
				 <i>Crema Marfil</i>	
				 <i>Marron Emperador</i>	
				 <i>Travertino Romano</i>	
				 <i>Negro Abanilla</i>	
				 <i>Rojo Alicante</i>	
				 <i>Rosa Claro</i>	
				 <i>Rosa Crema</i>	
				Weitere Natursteinausführungen auf Anfrage erhältlich.	

N28 Celine

Maßzeichnung

Frontansicht M 1:25

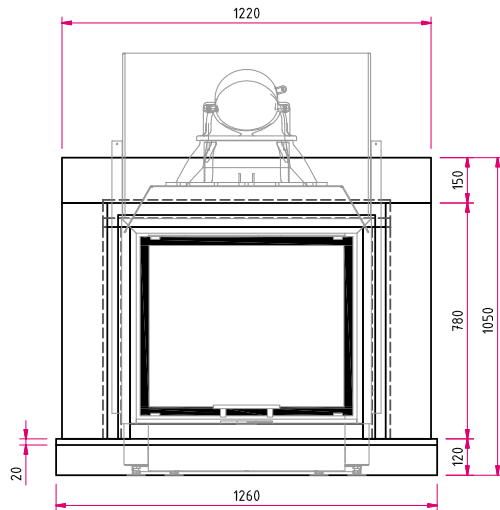

Seitenansicht M 1:25

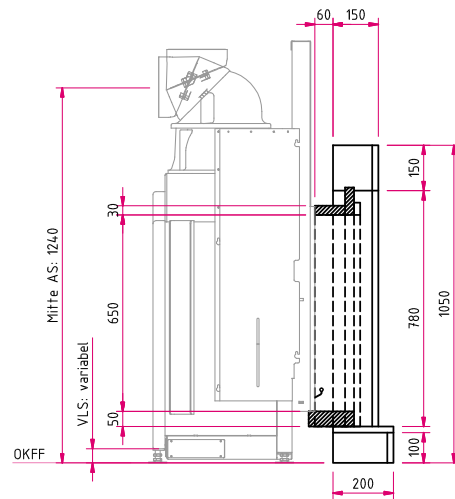

Draufsicht M 1:25

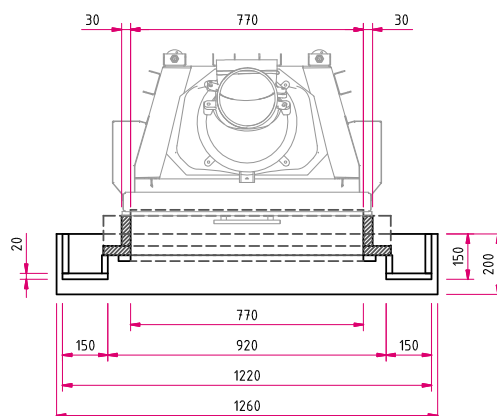

Hinweis Seitenansicht M 1:25: AS: Abgasstutzen, VLS: Verbrennungsluftstutzen, OKFF: Oberkante Fertigfußboden

Bitte beachten Sie die Angaben für **optionales Zubehör** in unserer Preisliste.

Abbildungen ähnlich. Alle Abbildungen und Zeichnungen sind urheberrechtlich geschützt. Verwertung oder Veröffentlichung, auch einzelner Details, nur mit unserer Genehmigung. Farbliche und technische Änderungen durch Weiterentwicklungen sowie Irrtümer vorbehalten. Stand: 07/2018