

























N34 Pisa

Datenblatt



Abbildung: N34 (Pisa) | Naturstein: Rosa Crema

Standard	Gesamtgewicht	Optional	Zubehör	Naturstein	Kamineinsatz
 Front Kristall	 ca. 420 kg	 Front Kristall + (außer Lina W)	 Heizwasser-Aufsatzregister R	 Kesselgerät Lina W	 Lina 7363 h NW-Leistung: 9 kW Abgasstutzen: Ø 200 mm  Energieeffizienzklasse nach (EU) 2015/1186 für Kamineinsatz Mehr Infos unter www.camina-schmid.de
 Tür hochschiebbar		 Doppelverglasung	 Aufsatzspeicher	 Wärmeluft-Aufsatzregister	
		 Tunnelversion	 Elektronischer Türantrieb	 Außenbefuerung	
			 SMR	 Vorlegeplatte	
				 Blanco Carrara	
				 Blanco Macael	
				 Blanco Nacarado	
				 Caliza Moka	
				 Crema Marfil	
				 Marron Emperador	
				 Travertino Romano	
				 Negro Abanilla	
				 Rojo Alicante	
				 Rosa Claro	
				 Rosa Crema	
				Weitere Natursteinausführungen auf Anfrage erhältlich.	

N34 Pisa

Maßzeichnung

Frontansicht M 1:25

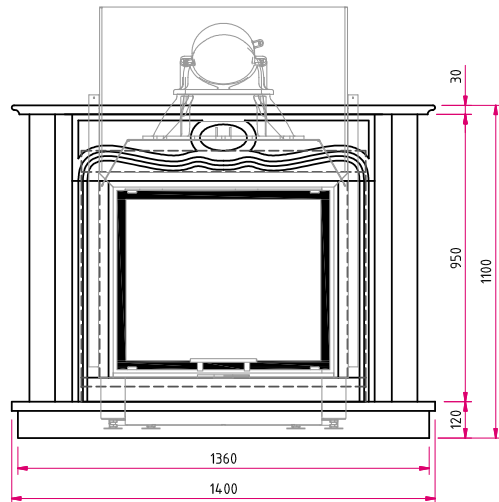

Seitenansicht M 1:25

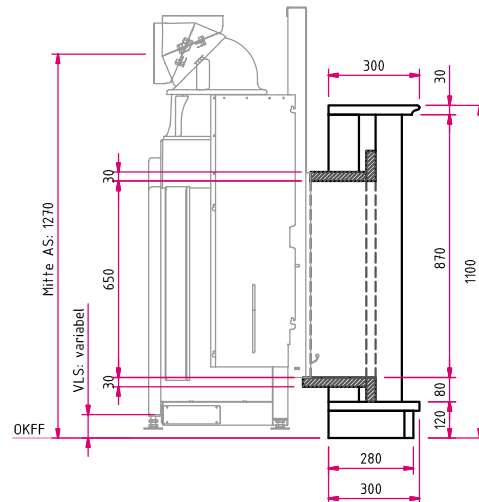

Draufsicht M 1:25

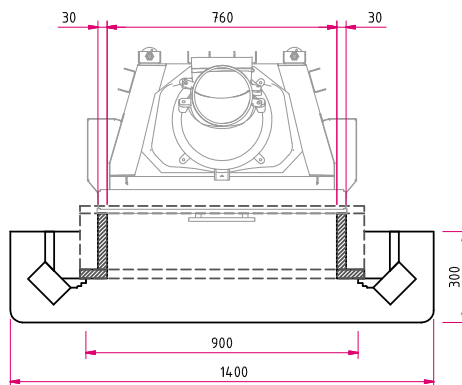

Hinweis Seitenansicht M 1:25: AS: Abgasstutzen, VLS: Verbrennungsluftstutzen, OKFF: Oberkante Fertigfußboden

Bitte beachten Sie die Angaben für **optionales Zubehör** in unserer Preisliste.

Abbildungen ähnlich. Alle Abbildungen und Zeichnungen sind urheberrechtlich geschützt. Verwertung oder Veröffentlichung, auch einzelner Details, nur mit unserer Genehmigung. Farbliche und technische Änderungen durch Weiterentwicklungen sowie Irrtümer vorbehalten. Stand: 07/2018