























# N36 Preston

## Datenblatt



Abbildung: N36 (Preston) | Naturstein: Rosa Claro

Standard	Gesamtgewicht	Optional	Zubehör	Naturstein	Kamineinsatz
 Front Kristall	 ca. 845 kg	 Doppelverglasung	 Wärmluft-Aufsatzregister	 Elektronischer Türantrieb	  Lina 10057 h NW-Leistung: 10 kW Abgasstutzen: Ø 200 mm   Energieeffizienzklasse nach (EU) 2015/1186 für Kamineinsatz  Mehr Infos unter <a href="http://www.camina-schmid.de">www.camina-schmid.de</a>
 Tür hochschiebbar		 Tunnelversion	 Außenbefeuerung	 SMR	
			 Vorlegeplatte	 Blanco Carrara	
				 Blanco Macael	
				 Blanco Nacarado	
				 Caliza Moka	
				 Crema Marfil	
				 Marron Emperador	
				 Travertino Romano	
				 Negro Abanilla	
				 Rojo Alicante	
				 Rosa Claro	
				 Rosa Crema	
				Weitere Natursteinausführungen auf Anfrage erhältlich.	

# N36 Preston

## Maßzeichnung

Frontansicht M 1:25

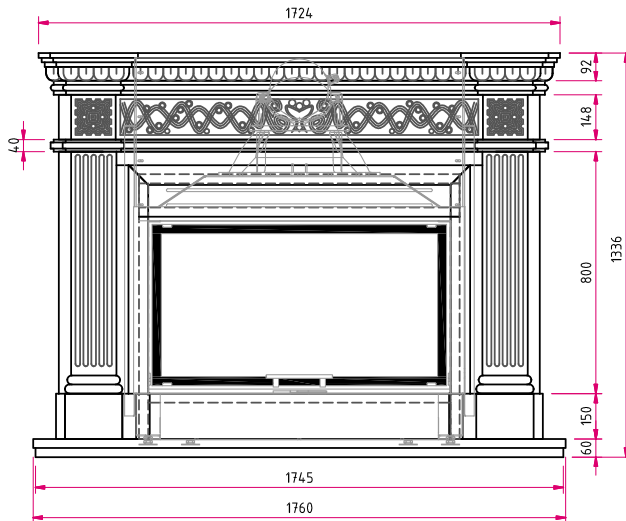

Seitenansicht M 1:25

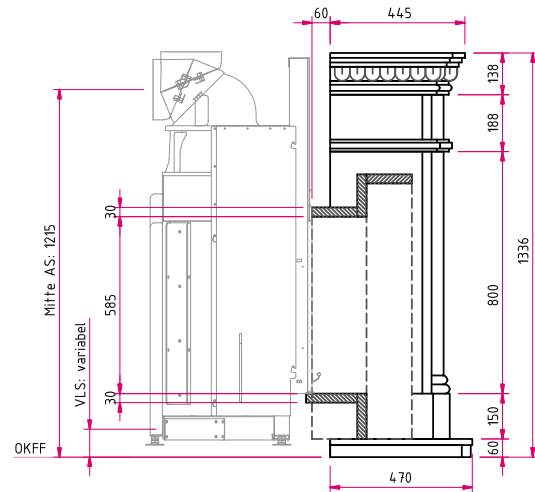

Draufsicht M 1:25

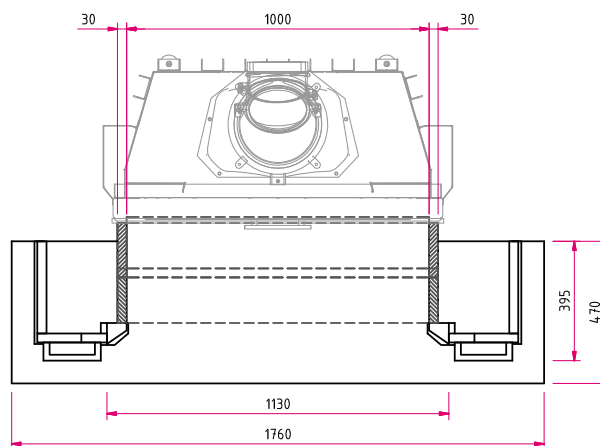

**Hinweis Seitenansicht M 1:25:** AS: Abgasstutzen, VLS: Verbrennungsluftstutzen, OKFF: Oberkante Fertigfußboden

Bitte beachten Sie die Angaben für **optionales Zubehör** in unserer Preisliste.

Abbildungen ähnlich. Alle Abbildungen und Zeichnungen sind urheberrechtlich geschützt. Verwertung oder Veröffentlichung, auch einzelner Details, nur mit unserer Genehmigung. Farbliche und technische Änderungen durch Weiterentwicklungen sowie Irrtümer vorbehalten. Stand: 07/2018