

Electric

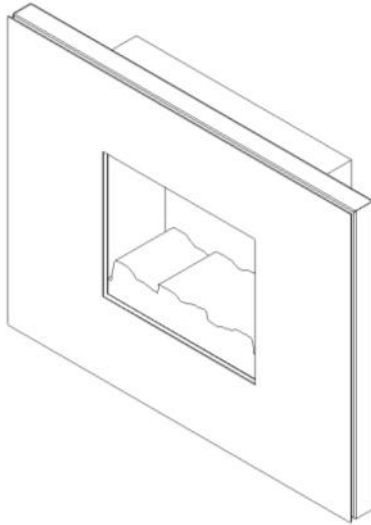

SENSES 3D

Dimensions

H 700 mm x W 900 mm x D 170 mm

Capacity

1,1 litres (filtered water)

Autonomy

8 hours

Voltage

220/240 V

Frequency

50 Hz

Lamps

4 x 50W Xenon Amber

Heat Power

1000 W—2000 W / 20 °C —25 °C
(depending of the room area)

Weight

40 kg

The product complies with the European Safety Standards EN60335-2-30 and the European Standard Electromagnetic Compatibility (EMC) EN55014, EN60555-2 and EN60555-3 These cover the essential requirements of EEC Directives 2006/95/EC and 2004/108/EC

glamm
fire

Congratulations on purchasing your GlammFire Electric appliance. This quality product has been designed with precision and rigour that characterizes us to offer you pleasant and soothing moments.

Please read the instructions for use carefully and effective before using the appliance.

Keep this Manual in a safe place.

Please read this manual before using your appliance and keep it for future reference. All presented warnings must be respected.

The information provided in this manual is subject to change without notice.

ÍNDICE

1—Material Fornecido	4
2—Important Safety Advice	5
3—General Information	6
3.1—Electrical connection	7
4—Installation Instructions	8
4.1—Before You Start	8
4.2—Installation	8
4.3—Connection the transducer	10
4.4—Remove water from the sump	12
5—Operating mode	13
5.1—Manual Controls	13
5.2—Remote control	13
5.2.1—Switching on the appliance	14
5.2.2—Adjust the flame setting	14
5.2.3—Switching on the heat	14
5.2.4—Setting the thermostat	14
5.2.5—Thermal safety cut-out	14
5.2.6—Setting the Date and Time	15
5.2.7—Operation modes of the remote control	15
5.2.8—Setting the timer modes	16
5.2.9— Manual mode	17
5.2.10— Protection against low temperatures	17
5.2.11—Screen Personalization	18
5.2.12—Remote control - features	18
6—Maintenance	19
6.1—Changing lamps	19
6.2—Cleaning	19
6.3—Water tank	19
6.4—Sump	20
6.5—Air filter	20
7—Troubleshooting	21
8—Overall dimensions	22
9—Warranty	23

1—Supplied material:

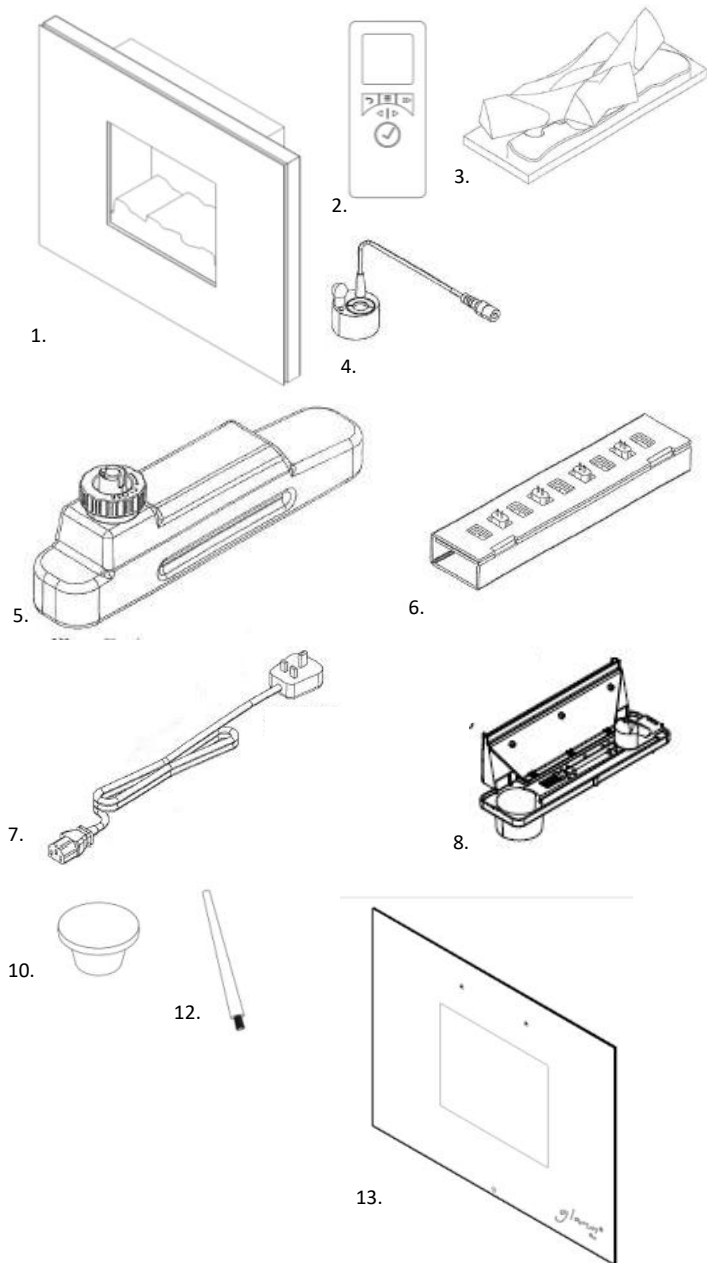

1. Senses 3D;
2. Remote control;
3. Decorative firewood;
4. Transducer;
5. Water tank;
6. Set of lamps;
7. Electric cable;
8. Nozzle;
9. Remote control base
10. 4xLamps;
11. Screw kit;
12. Cleaning brush;
13. Template.

2—Important Safety Advice

When using electrical appliances, basic precautions should always be followed to reduce the risk of fire, electrical shock and injury to persons, including the following:

If the appliance is damaged, check with the supplier before installation and operation.

- Do not use outdoors.
- Do not use in the immediate surroundings of a bath, shower or swimming pool.
- Do not locate the heater immediately below a fixed socket outlet or connection box.

This appliance is not intended for use by children or other persons without assistance or supervision if their physical, sensory or mental capabilities prevent them from using it safely. Children should be supervised to ensure that they do not play with the appliance.

WARNING: This appliance requires ground connection.

It is not recommended to use an extension cable to connect this product to the electricity network. This connection through this device can cause a risk of overload, overheating and even fire hazard.

It must only be used with an alternating current voltage and the voltage marked on the appliance.

Do not use this appliance in series with a temperature control, program controller, timer or other type of appliance that automatically switches on the heater, as there is a danger of fire if the appliance changes position or is covered accidentally.

In the event of a fault, turn off the heater.

Unplug the heater when not required for long periods.

Although this heater complies with safety standards, we do not recommend its use on deep pile carpets or on long hair type of rugs.

Ensure that furniture, curtains or other combustible material are positioned no closer than 1 metre from the heater.

In the event of a fault unplug the heater.

The appliance must be positioned so that the plug is accessible.

If the supply cord is damaged it must be replaced by the manufacturer or service agent or a similarly qualified person in order to avoid a hazard.

Keep the supply cord away from the front of the heater.

WARNING: In order to avoid overheating, do not cover the heater. Do not place material or garments on the heater, or obstruct the air circulation around the heater.

The heater carries a DO NOT COVER warning.

WARNING: To avoid risk due to unintentional restart of the thermal commutator, this device must not receive power from a device with an external switch, such as a timer, or connect to a circuit with automatic connection and disconnection by the electricity company.

3—General information

Unpack the heater carefully and retain the packaging for possible future use, in the event of moving or returning the fire to your supplier.

The fire incorporates a flame effect, which can be used with or without heating, so that the comforting effect may be enjoyed at any time of the year. Using the flame effect without selecting heat requires little electric power.

Always ensure that the appliance is fixed to the wall in a level position.

Before turning on the heater, check that the supply voltage corresponds to the voltage indicated on the heater.

Use only filtered water on this device.

Once installed, do not move the appliance or lay it on its back without draining the water from the deposit and the water tank. The water tank, deposit, deposit cover, tank cover and air filters should be cleaned every 2 weeks, particularly in hard water areas. If you do not intend to use the appliance for more than two weeks, remove the water from the deposit and the tank and dry them.

Please note: If the unit is used in an environment where the background noise is quite low, you may hear a sound related to the operation of the flame effect. This is normal and should not worry.

The deposit and the water tank of these products contain a treatment of harmful or unwanted organisms.

A fan heater can provide warmth in cold climates.

Do not drink the water from the sump or from the sump or from the water tank(s).

Heat Output	230V	240V
Nominal Heat Output (P _{nom.})	1,8kW	2,0kW
Minimum Heat Output (P _{mín.})	0,9kW	1,0kW
Maximum Continuous Heat Output (P _{máx.})	1,8kW	2,0kW
Auxiliary Electricity Consumption		
In Standby Mode (P _{Nom.})	0,45kW	0,48kW

3.1—Electrical connection:

WARNING – THIS APPLIANCE MUST BE EARTHED.

This heater must be used on an AC supply only and the voltage marked on the heater must correspond to the supply voltage.

Before switching on, please read the safety warnings and operating instructions.

PLEASE RETAIN THIS USER'S GUIDE FOR FUTURE REFERENCE

The appliance should never be operated if the lamps are not working.

The lamps should be regularly inspected as described under 'Maintenance' and 'Changing lamps'.

4—Installation instructions

4.1—Before You Start

1. Ensure that all packing items are removed (read any warning labels carefully).
2. Retain all packing for possible future use, in the event of moving or returning the appliance to your supplier.

4.2—Installation

To install the unit:

1. Clean the area where the fire will be installed;
2. Remove the back wall bracket of the appliance by removing the two screws with which the wall bracket is fixed. From the ground to the appliance there should be a minimum distance of 300 to 600mm, the distance to a side wall should be at least 625mm and from the top of the appliance to a shelf the distance should be 150mm (Figure 1);

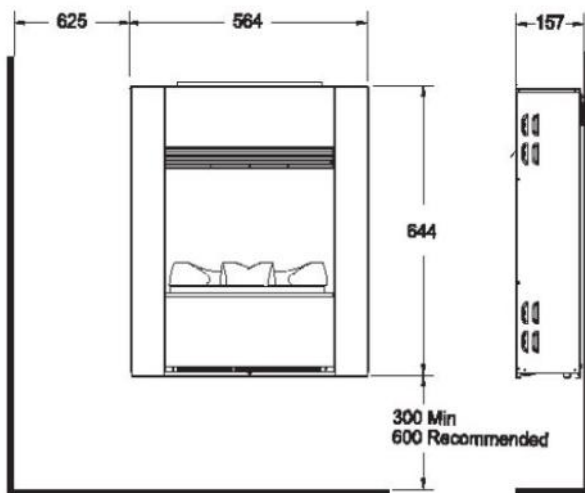

Figure 1- Installation dimensions

3. Fix the wall bracket to the wall making sure it is level, using the wall plugs and screws supplied for blocks walls.

4. Rotate the safety fixation bracket on the base so that the fixation is visible, marking the wall
5. Hang the unit on the fixed wall bracket. Turn the safety fixation bracket on the base of the product so that the fixation hole is exposed. Mark this hole and remove the fixation device. Secure the bushing to the wall in the marked position.
6. Hang the appliance again on the wall fixation bracket and secure it in place using the screw provided through the safety fixation bracket (Figure 2).

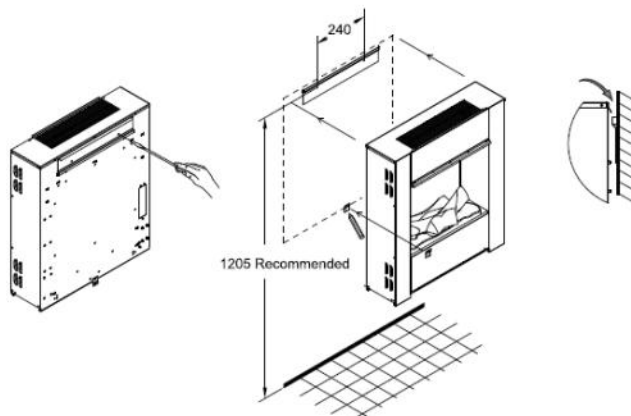

Figure 2- Installation of the appliance

7. Ensuring that the appliance is switched off
8. Connect the appliance to a power source of 13 A /240 V.

WARNING: The customer must be careful to avoid electric cables when drilling the wall to place the wall brackets.

4.3—Connection the transducer

1. Remove the wood from the appliance;
2. Carefully lift the tank and set it aside (Figura 3);



Figura 3- Removal of firewood and tank;

3. Remove the nozzle by un-clipping and lifting upwards and outwards;.
4. Inserting the lamps according to figure 4.

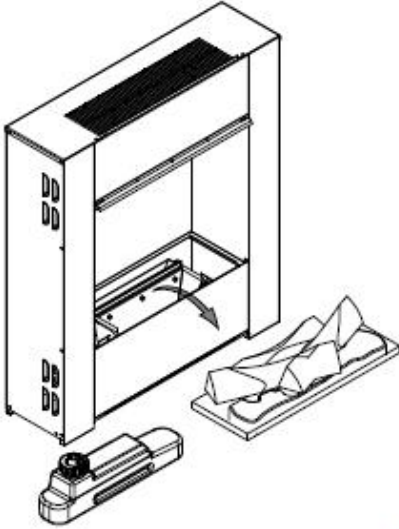
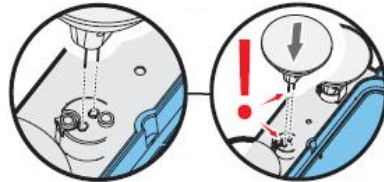
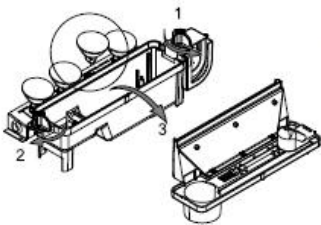

Figure 4- Placing the lamps

5. Locate the tab on the transducer unit into the moulded recess in the base of the sump. Ensure that the cable does not obstruct the transducer disc. To prevent the cable becoming pinched between the nozzle and the sump, place the cable in the slot in the wall of the sump.

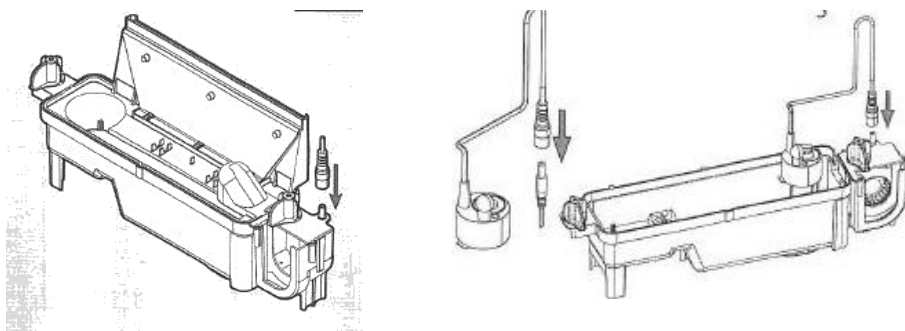

Figure 5- Connection the transducer

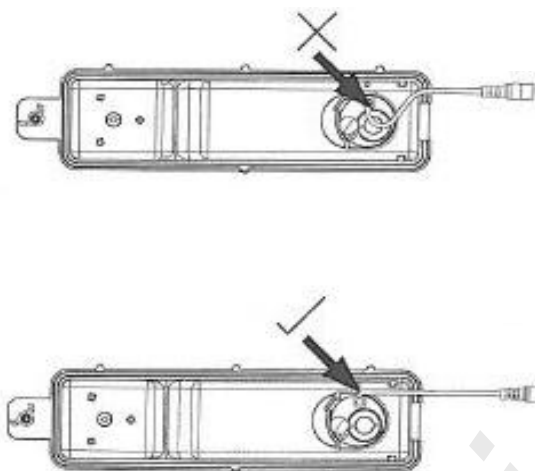

Figure 6- Placing the transducer cable

6. Replace the tank nozzle. Then fill the tank with water and place it inside the appliance.

4.4—Remove water from the sump

1. Disconnect the appliance from the mains;
2. Remove the wood, tank and nozzle. Then remove the transducer and clean it;
3. Remove the sump and pour the water to a desired location;
4. Replace all the above components and then turn the unit on.



WARNING: When the sump is empty, the flame effect and the steam will turn off, 2x beeps will be heard and C d 0 1 . will appear on the screen.

Figure 7- Remove water from the sump

5—Operating mode

5.1—Manual controls

The manual controls are located on the base of the appliance.

Switch “A” : Controls the electricity supply to the Fire.

Note: This switch must be in the “ON” (I) position for the Fire to operate with or without heat when activated.

Switch “B”: Press  once to turn on the flame effect.

This will be indicated by na audible “beep”.

Although the main lights operate immediately it will take a further 45 seconds before the flame effect starts.

Press  to put fire into standby mode. This will be indicated by one “beep”.

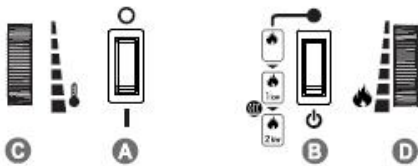
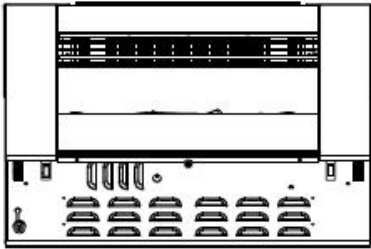

Figure 8- Manual controls

5.2—Remote control

The remote control is packed with 2AA batteries.

To insert the batteries, lift the remote control cover from the rear and insert them, taking into account the polarity (Figure 9).

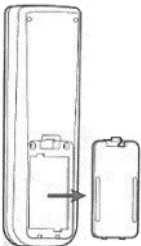





Figure 9- Opening the remote control

5.2.1—Switching on the appliance

Press and hold the button  for 3 seconds to activate the remote control. FIRE will be displayed and ON will be blinking.

Press  to switch on the appliance. To turn off the appliance press  so that FIRE is blinkin, press  twice.



5.2.2—Adjust the flame setting

With the remote control activated, press once  FIRE will be blinking on the display. Press 



The current flame setting will be displayed F1-F6.Press  t h e  and buttons to adjust the setting.

After have selected the flame setting press  twice to exit the menu and return to the home screen.

5.2.3—Switching on the heat

With the remote control activated press  once. FIRE will be blinking on the display. Press  once, HEAT will be blinking.

Press 

The current heat setting will be displayed OFF LO HI. Press the  and  buttons to adjust the setting.

After have selected the flame setting press 

5.2.4—Setting the thermostat

The temperature shown on the display is the room temperature set point. This is the temperature that the heater will maintain during the heating periods. If the room temperature is above this temperature then the heater will not operate.

The heater leaves the factory with this temperature set as 15°C which represents a typical comfortable room temperature.

If the require different room temperature then press the  o r  home screen until the display shows the temperature required.





















5.2.5—Thermal safety cut-out

A thermal safety cut-out is incorporated in the fan heater to prevent damage due to overheating. This can happen if the heat outlet was restricted in any way. If the cut-out operates, unplug the heater from the socket outlet and allow approximately 10 minutes before reconnecting. Before switching the heater back on remove any obstruction that may be restricting the heat outlet, then continue normal operation.

Caution: In order to avoid a hazard due to inadvertent resetting of the thermal cut-out, this appliance must not be supplied through an external switching device, such as a timer, or connected to a switch that is regularly switched on and off by utility.

5.2.6—Setting the Date and Time

To set the date and time on the unit:

1. Press the button 
1. Press the button  4 times
3. Press the button  when the date and time icon blinks
4. Press  and  to set the hour
5. Press  and  to set the time and click on 
6. Press  and  to set the minutes, then click on  to confirm the time
7. Press  and  to set the day and click on 
8. Press  and  to set the month and click on 
9. Press  and  to set the year and click on  to confirm the date.

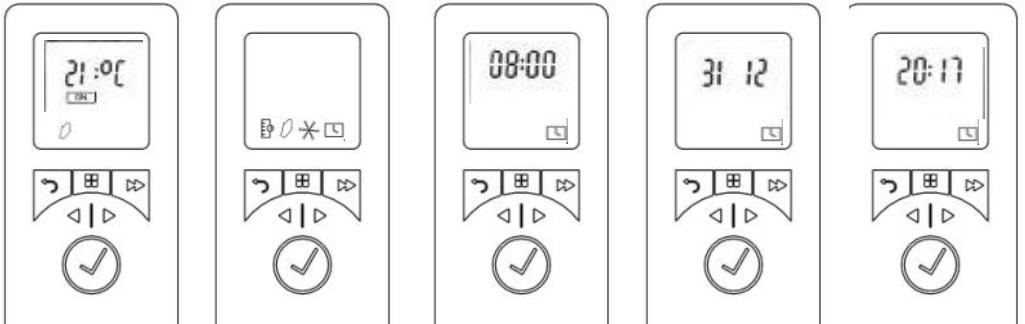

5.2.7—Operation modes of the remote control

Setting the timer

Provides greater flexibility to the user. There are four time slots available throughout the day that can be customize for each day of the week. Consult "Setting the timer modes" for instructions on adjusting period times and temperature.

Manual mode: This mode warms the room to the temperature set by the remote control.

Protection against low temperatures:







This mode should be used for low temperature protection as indicated by the icon .

Protection against low temperatures:

The low temperature protection mode maintains an ambient temperature of 7 °C .

5.2.8—Setting the timer modes

To set the timer:

1. Press the button 
2. Press the button  once to program the icon  and click on 
3. Press  twice and click on 

Note: The days of the week are indicated at the top of the screen

Day 1= Monday

Day 2= Tuesday





















Day 4= Wednesday



Day 5= Thursday



Day 5= Friday

Day 6= Saturday

Day 7= Sunday



4. Press to modify Day 1 and click on  to navigate to the desired day and press 
5. P1 is indicated on the screen
6. Press  to select P1, to choose P2, P3 and P4 press  and click on 
7. The display shows ON (turned on), press  to set the time
8. Press  and  to set the time and click on  to confirm
9. Press  and  to set the minutes and click on  to confirm
10. Press  and  to set the temperature and click on  to confirm
11. Press  and  to set the time to turn off and click on  to confirm
12. Press  and  to set the minutes to turn off and click on  to confirm

Press  to modify the Program P2, follow the steps in 5-12 and click on  to switch to P3.

Press  to modify the Program P3, follow the steps in 5-12 and click on  to switch to P4.

Press  to modify the Program P4, follow the steps in 5-12

To copy the recently programmed P1-P4 programs to the other days, click on 
COPY is displayed on the screen.

To copy the next day's settings in sequence, press the  button, to deselect the next day of the sequence, click on 

The days of the week that are selected are indicated at the top of the screen. Days that are cleared will not be visible.

Press  to confirm the backlight will blink and return to the beginning.

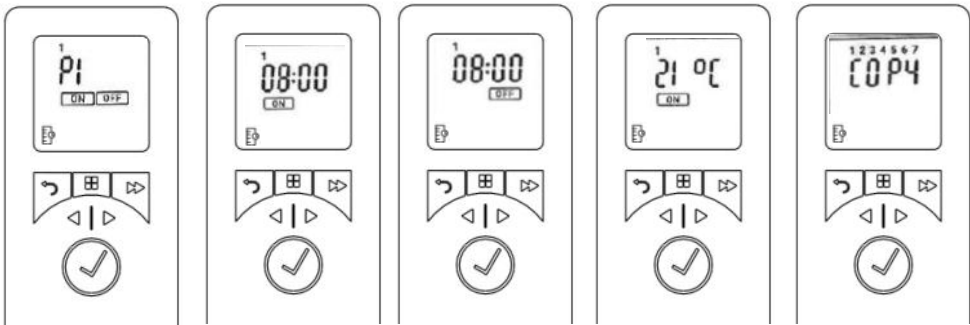
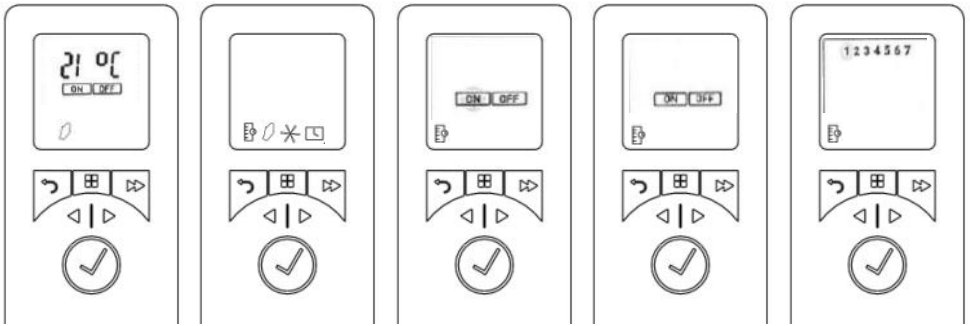

5.2.9—Modo manual

To select a constant heat mode. This mode ignores the timer and maintains the displayed temperature.

1. Press the button
2. Press the button twice to highlight the hand icon and click on to confirm
3. Use to set the desired temperature

5.2.10—Protection against low temperatures:

The low temperature protection mode maintains an ambient temperature of 7 °C for 24 hours.

1. Press the button
2. Press the button three times to highlight the snowflake icon and confirm the button
3. Press the button to and exit this mode and enter manual mode.



5.2.11—Screen Personalization:

The maximum temperature setting of the product is 32°C. You have the option to reduce this temperature and to change from °C to °F.

1. Press the button
2. Press the button twice and the SP message will flash, then click on to confirm
3. Press the button and to select between °C or °F and click the button to confirm
4. Press to and select the maximum temperature set point and click on to confirm
5. Press three times to return to the home screen

5.2.12—Remote control - features

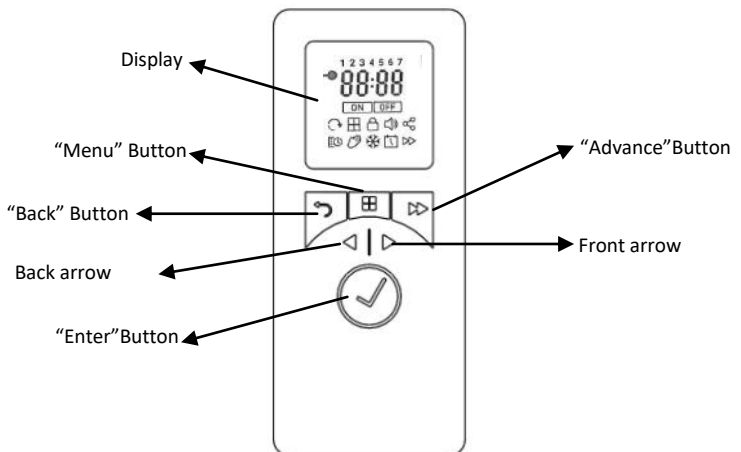

6—Maintenance

WARNING – ALWAYS DISCONNECT FROM THE POWER SUPPLY BEFORE CLEANING THE HEATER.

6.1—Changing lamps

If there is a large amount of gray or colorless smoke, it is likely that one or more bulbs have melted. You can check the lamp failure as follows:

1. Leaving the effect flame turned on, remove the nozzle, tank and water tank.
2. Observe the lamps from a distance and confirm which lamps have to be replaced.
3. Press the switch "A" to the off position (0) and disconnect the appliance from the mains.
4. Do not tamper with the equipment for 20 minutes to allow the lamps to cool down before removing them.
5. Remove the water tank by lifting it up and placing it in a sink.
6. Remove the tank as described in the Cleaning section.
7. Remove the defective lamp by carefully lifting it upright and undocking the pins of the lamp support. Replace with a colored lamp, with a beam width of 80, base Gu5.3, 50 W, 12 V.
8. Carefully insert the two new lamp pins into the two holes of the lamp support. Press the lamp firmly.
9. Replace the nozzle, deposit and water tank.
10. Switch on the appliance after everything is set.

6.2—Cleaning

WARNING: BEFORE CLEANING THE APPLIANCE, ALWAYS DISCONNECT THE APPLIANCE. LET IT COOL FOR 10 MINUTES TO ALLOW THE APPLIANCE TO COOL DOWN.

We Recommend cleaning the following components once every 2 weeks, particularly in hard water areas:
Water Tank, Sump, Nozzle, Tank cap and seal, Air filter.

For general cleaning use a soft clean duster – never use abrasive cleaners. To remove any accumulation of dust or fluff the soft brush attachment of a vacuum cleaner should occasionally be used to clean the outlet grille of the fan heater.

6.3—Water tank

1. Remove the water tank as described previously, place it in the sink and empty the water.
2. With the supplied brush, rub the inside surfaces of the cover, paying close attention to the plastic ring of the outer and central groove.
3. Put a small dose of non-abrasive detergent and place the cover again and shake well. Rinse until all detergent has disappeared.
4. Fill the tank with filtered water and place the cover again without over tightening.

6.4—Sump

1. Press to  place the product on "standby"
2. Carefully lift the tank nozzle and the water tank and place them on the ground.
3. Remove the sump by lifting it up and out
4. Slope the water tank in a sink so that the liquid exits
5. Put a small dose of non-abrasive detergent and rub with the supplied brush all the surfaces
6. Rinse thoroughly and clean the component. Reverse previous steps to reassemble it

6.5—Air filter

1. Turn off the device
2. Gently lift out the sump and place carefully on the ground.
3. Gently slide upwards the air filter out of its plastic holder. (Figure 10).
4. Gently rinse with water in the sink and dry with fabric towel before returning.
5. Replace the filter making sure that the coarse black filter is facing the front of the fire.
6. Replace the sump.
7. Turn on the device

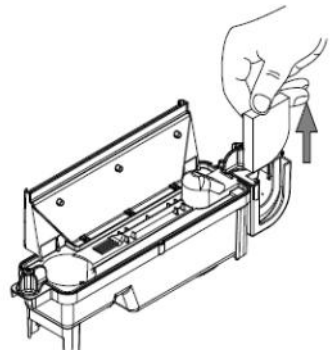

Figure 10- Cleaning the air filter

CAUTION: It is recommended that some necessary arrangements are made by a qualified electrician.

7—Troubleshooting

Symptom	Cause	Corrective Action
The flame effect will not start.	Mains plug is not plugged in. Low water level. Low voltage connector not connected properly. The Transducer Unit is not sitting correctly in the sump.	Check plug is connected to wall socket correctly. Check that the water tank is full and there is water in the sump. Check that the connector is inserted correctly. Ensure the Transducer is sitting down into the moulded recess in the sump.
The flame effect is too low.	Flame effect control knob is set too low. The Metal Disc in the transducer might be dirty The wire from the Transducer Unit is sitting over the metal disc.	Increase level of flame by turning Control knob 'D' to the left slowly. Clean the Metal Disc with soft brush supplied. Direct the wire to the back of the sump and make sure it sits into the side slot exiting the sump.
Unpleasant smell when unit is used.	Dirty or stale water. Using unfiltered tap water.	Clean the unit as described under maintenance. Use only filtered tap water.
The flame effect has too much smoke.	Flame effect setting is too high.	Decrease the flame level by changing the FIRE setting on the remote control.
Main lamps are not working and there are no flames or smoke.	There is no water in the water tank.	Filling the water tank. Check the plug is connected to the Wall socket correctly and that Switch 'A' is in the 'ON' (I) position.

8—Overall dimensions

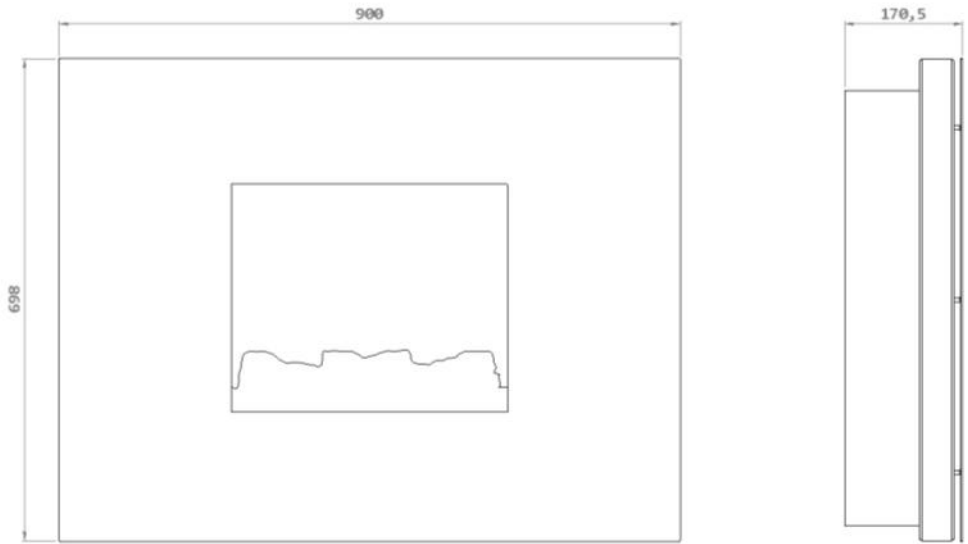

9—Warranty

Equipment: Version: Controller:	Guarantee beneficiary: Adress: Tel.: Availability date: Local.....Date..... Signature
Series and Guarantee numbers:	
Distributor code:	
Name and adress of the distributor:	

Guarantee

This Electric Appliance carries a guarantee against defects of manufacture and faulty workmanship for a period of 2 years from the date of purchase. This does not apply to the batteries, whose lifespan, regrettfully, we cannot predict. All guarantee periods commence on the date of purchase and are non-transferable.

Our guarantee is offered as an addition to your statutory rights.

The guarantee is applicable to the original purchaser only, non-transferable.

Use of spare parts other than those supplied by the manufacturer will invalidate the appliance guarantee and must only be fitted by an authorised service engineer.



Recuperadores Pachinha Lda.
Zona Industrial da Lagoa, Lote G1
4950-850 CORTES - MONÇÃO PORTUGAL
Tel(+351) 251 654 800
Fax(+351) 251 654 801
info@glammfire.com
www.glammfire.com



Management
System
ISO 9001:2008
ISO 14001:2004



www.tuv.com
ID 9105063633